



193A

Digital Automotive Multimeter Instruction Manual

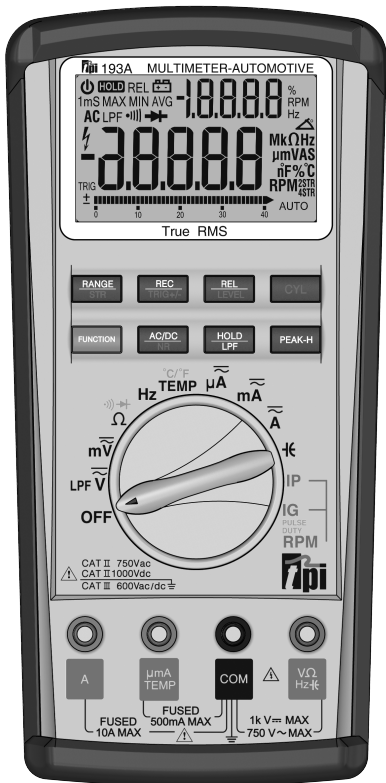

TABLE OF CONTENTS

A.	INTRODUCTION	
1.	Congratulations	3
2.	Product Description	3
3.	EC Declaration of Conformity	4
B.	SAFETY CONSIDERATIONS	5
C.	TECHNICAL DATA	
1.	Features and Benefits	6
2.	Product Applications	7
3.	Specifications	8-10
D.	MEASUREMENT TECHNIQUES	
1.	Controls and Functions	11
a)	Push Buttons	11-12
b)	Rotary Switch	12
c)	Input Jacks	12
d)	Disable Auto Power Off	12
2.	Step by Step Procedures:	
a)	Measuring DC Volts	13
b)	Measuring AC Volts	14
c)	Measuring DC Amps	15
d)	Measuring AC Amps	16
e)	Measuring Resistance	17
f)	Measuring Diodes	18
g)	Continuity Buzzer	19
h)	Measuring Capacitance	20
i)	Measuring Temperature	21
j)	Measuring Frequency	22
j)	IP Function	23
k)	IG Function	24
l)	REC Function	25
m)	REL Function	25
n)	LPF Function	26
o)	PEAK-H Function	26
p)	RS 232 Function	27

F. MAINTENANCE

1. Testing Fuses in Circuit28
2. Fuse Replacement28
3. Battery Replacement29
4. Cleaning Your Meter29

A. INTRODUCTION

1. Congratulations!!

Thank you for purchasing TPI brand products. The meter is easy to use and is built to last. It is backed by a 5 year limited warranty. Please remember to complete and return your product warranty registration card.

2. Product Description

The 193A is a hand-held True RMS autoranging automotive DMM. The 193A measures ACV, DCV, ACA, DCA, Resistance, Frequency, Capacitance, Duty Cycle, Diodes, Continuity, Temperature, RPM, Dwell, and milli-second pulse width. It also has optically isolated RS232 output for connecting to a PC.

The 193A also features:

- RANGE Allows the user to manually range the 193A instead of autoranging.
- REC Records Min/Max readings during specified measurement intervals.
- HOLD Holds the reading on the display for easy viewing.
- REL Displays the value as a difference to a reference value
- AUTO OFF Preserves battery life.
- PEAK-H 1 millisecond peak hold to capture spikes in signals.
- LPF Low Pass Filter for filtering noise and harmonics
- LEVEL Adjustable trigger level for automotive functions
- NR Noise reduction for automotive functions.

The 193A comes complete with the following accessories:

- 193A Instrument
- Rubber Boot
- Test Lead Set
- Inductive Pick-up
- Temperature Probe and input adapter
- Instruction Manual

3. EC Declaration of Conformity

This is to certify that model 193A conforms to the protection requirements of the council directive 89/336/EEC, in the approximation of laws of the member states relating to Electromagnetic compatibility and 73/23/EEC, The Low Voltage Directive by application of the following standards:

- EN61326 : 1997 + A1 + A2 : 2001
- EN61010-1 :2001 Safety Standard

To ensure conformity with these standards, this instrument must be operated in accordance with the instructions and specifications given in this manual.

CAUTION:

Even though this instrument complies with the immunity standards, the accuracy can be affected by strong radio emissions not covered in the above standards. Sources such as hand held radio transceivers, radio and TV transmitters, vehicle radios and cellular phones generate electromagnetic radiation that could be induced into the test leads of this instrument. Care should be taken to avoid such situations or alternatively, check to make sure that the instrument is not being influenced by these emissions.

B. SAFETY CONSIDERATIONS



WARNING: Please follow manufacturers test procedures whenever possible. Do not attempt to measure unknown voltages or components until a complete understanding of the circuit is obtained.



Read instructions before operating:
Be sure these instructions accompany the tool when passed from one user to a new or inexperienced user.



Equipment is used in a manner not specified by the manufacturer, the protection provided by the equipment may be impaired.

GENERAL GUIDELINES

ALWAYS

- Test the 193A before using it to make sure it is operating properly.
- Inspect the test leads before using to make sure there are no breaks or shorts.
- Double check all connections before testing.
- Have someone check on you periodically if working alone.
- Have complete understanding of circuit being measured.
- Disconnect power to circuit then, connect test leads to the 193A, then to circuit being measured.

NEVER

- Attempt to measure unknown high voltages.
- Attempt to measure current with the meter in parallel to the circuit.
- Connect the test leads to a live circuit before setting up the instrument.
- Touch any exposed metal part of the test lead assembly.

INTERNATIONAL SYMBOLS



DANGEROUS VOLTAGE



AC (ALTERNATING CURRENT)



DC (DIRECT CURRENT)



REFER TO INSTRUCTION MANUAL



GROUND



FUSE



DOUBLE INSULATION

C. TECHNICAL DATA

1. Features and Benefits

Agency Approval	Meets CE and IEC 61010-1 requirements. UL Listed to U.S. and Canadian Safety Standards.
True RMS	Accurately measure non-linear AC signals for on ABS and other sensors.
Auto Power OFF	Instrument automatically powers off after 15 minutes of inactivity. Pressing the FUNCTION button turns the unit back on.
Battery/Fuse Compartment	Separate battery/fuse compartment makes replacement quick and easy.
Built-in Tilt Stand	Sturdy tilt stand built directly into the instrument housing.
5 Year Warranty	Covered by a standard 5 year warranty.

2. Product Applications

Perform the following tests and/or measurements with the TPI 193A and the appropriate function:

HVAC/R

FUNCTION

- | | |
|------------|--|
| DCmV | • Thermocouples in furnaces or gas applications. |
| ACA | • Heat anticipator current in thermostats. |
| ACV | • Line voltage. |
| ACV or DCV | • Control circuit voltage. |
| DC μ A | • Flame safeguard control current. |
| OHMS | • Heating element resistance (continuity). |
| OHMS | • Compressor winding resistance. |
| OHMS | • Contactor and relay coil resistance. |
| OHMS | • Continuity of wiring. |

ELECTRICAL

- | | |
|------|--------------------------------------|
| ACV | • Measure line voltage. |
| OHMS | • Continuity of circuit breaker. |
| DCV | • Voltage of direct drive DC motors. |

AUTOMOTIVE

- | | |
|-------------|--|
| DCV | • Battery and circuit voltage. |
| OHMS | • Continuity of wires and fuses. |
| ACV | • ABS brake sensors. |
| DCmA | • Circuit current draw |
| Hz | • Frequency of signals |
| RPM | • Engine speed |
| Duty Cycle | • "On time" of signals |
| Dwell Angle | • Conventional ignition point setting |
| Temperature | • Inlet and outlet of catalytic converters |

3. Specifications



IEC 61010-1 Over Voltage:
 CAT II - 1000V
 CAT III - 600V
 Pollution Degree 2



MEASURING EQUIPMENT

E188344 UL61010-1
 28DK CAT II 750VAC/1000VDC
 CAT III 600VAC/DC

a. DCV

Range	Resolution	Accuracy	Impedance
20mV	0.001mV	±(0.1% + 5 digits)	10MΩ
200mV	0.01mV		
2V	0.0001V		
20V	0.001V		
200V	0.01V		
1000V	0.1V		

b. ACV

Range	Resolution	Accuracy	Impedance
400mV	0.01mV	±(0.75% +40 digits) (45Hz ~ 450Hz)	10MΩ
2V	0.0001V		
20V	0.001V		
200V	0.01V		
750V	0.1V		

c. DCA

Range	Resolution	Accuracy	Overload Protection
200μA	0.01μA	±(0.3% +10 digits)	Fuse 0.5Amp/600V
2000μA	0.1μA		
20mA	0.001mA		
200mA	0.01mA	±(0.75% +10 digits)	Fuse 10Amp/600V
2A	0.0001A		
10A	0.001A		

*Warning: Use only correct size, voltage and current rated fuses.
 Test Leads: Use only correct type and overvoltage category rating.

d. ACA

Range	Resolution	Accuracy	Overload Protection
200 μ A	0.01 μ A	$\pm(0.75\% + 10 \text{ digits})$	Fuse 0.5Amp/600V
2000 μ A	0.1 μ A		
20mA	0.001mA		
200mA	0.01mA		
2A	0.0001A	$\pm(1.5\% + 10 \text{ digits})$	Fuse 10Amp/600V
10A	0.001A		

e. OHM (Resistance, Ω)

Range	Resolution	Accuracy	Overload Protection
200 Ω	0.01 Ω	$\pm(0.1\% + 5 \text{ digits})$	600V DC or AC Peak
2k Ω	0.0001k Ω		
20k Ω	0.001k Ω		
200k Ω	0.01k Ω		
2M Ω	0.0001M Ω		
20M Ω	0.001M Ω	$\pm(0.75\% + 15 \text{ digits})$	

f. Frequency (Hz)

Range	Resolution	Accuracy	Overload Protection
20Hz	0.001Hz	$\pm(0.05\% + 2 \text{ digits})$	600V DC or AC Peak
200Hz	0.01Hz		
2KHz	0.0001KHz		
20KHz	0.001KHz		
200KHz	0.01KHz		
2MHz	0.0001MHz		
10MHz	0.001MHz		

g. Capacitance

Range	Resolution	Accuracy	Overload Protection
40nF	0.01nF	$\pm(3\% + 10 \text{ digits})$	600V DC or AC Peak
400nF	0.1nF		
4 μ F	0.001 μ F		
40 μ F	0.01 μ F		
400 μ F	0.1 μ F		
4mF	0.001mF		
10mF	0.01mF	$\pm(5\% + 10 \text{ digits})$	

h. Temperature (K-Type)

Range	Resolution	Accuracy
-40 to 1,350°C	0.1°C	$\pm(1.5^\circ\text{C} + 1 \text{ digit})$ (-20 to 300°C) $\pm 3\%$ of reading rest of range
-40 to 1999°F	0.1°F	$\pm(3^\circ\text{C} + 1 \text{ digit})$ (-4 to 572°F) $\pm 3\%$ of reading rest of range
2000 to 2462°F	1°F	

i. Automotive Functions

Function	Range	Resolution	Accuracy
RPM IG	RPM	60 to 12,000	± 2 RPM
	Duty Cycle	0.0 to 99.9%	$\pm 2\%$ per kHz, +0.1% (Pulse width > 0.5mS)
	Dwell	0.0 to 356.4°	Pulse width > 0.5mS
	Pulse Width	0.2 to 199.9mS	$\pm 2\%$ per kHz, +0.1% ± 1 digit (Pulse width > 0.5mS)
	Frequency	1 Hz to 1999.9Hz	0.05% of reading, ± 2 digits
RPM IP	RPM	60 to 12,000	± 2 RPM

j. Diode Test

Test Voltage	Max Test Current	Over Load Protection
3V	Approx. 1mA	600 V DC or Peak AC

k. Continuity Buzzer

Test Voltage	Threshold	Over Load Protection
3V	< 30 Ω	600 V DC or Peak AC

l. General Specifications

Max. Volt. between any Input and Ground	1000V
Fuse Protection	mA: 0.5Amp/600VAC A: 10Amp/600VAC
Display Type	20,000 Count, 2 times per second update
Operating Temp.	0° to 40°C (32° to 104°F)
Storage Temp.	-10° to 50°C (14° to 122°F)
Relative Humidity	0% to 80%
Power Supply	2 Each 1.5 Volt "AA" Batteries
Battery Life	200 hrs. Typical
Size (H x L x W)	33mm x 86mm x 187mm (1.3in x 3.4in x 7.4in)
Weight	340g (12oz)

D. MEASUREMENT TECHNIQUES

1. Controls and Functions:

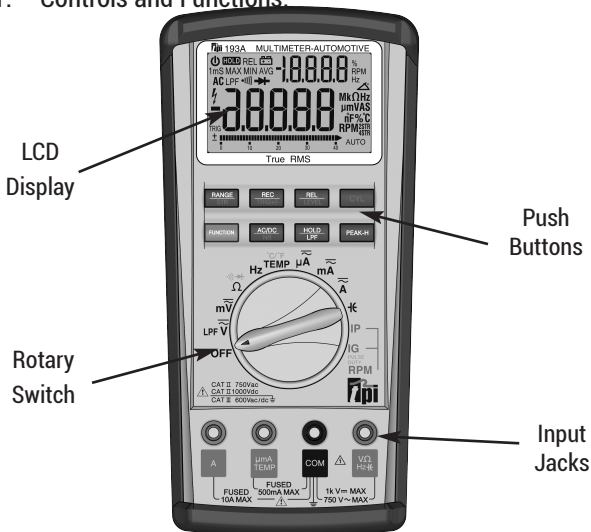

a. Push Buttons



Activates manual ranging. Hold in for 2 seconds to return to autorange.
Toggles between 2 or 4 stroke in IG function.



Activates the Min/Max Record mode. Auto Power Off is disabled in this function. Hold in for 2 seconds to deactivate.



Activates relative mode (see page).
Advances the trigger level in IP and IG functions.



Toggles from 1 to 12 cylinders in IG function.
Hold down for 2 seconds to disable auto power off.



Toggles between Continuity Buzzer or Diode test on Ohm function.
Toggles between C or F on Temperature function.
Toggles between RPM, mS pulse width, duty cycle, or dwell angle on IG function.



Toggles between AC or DC on Volt and Current functions.
Activates NR (Noise Reduction) on IP and IG functions.

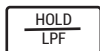







Activates Data Hold on non-automotive functions. Press again to deactivate. Hold down for 2 seconds to activates LPF (Low Pass Filter) on AC and DC volt functions.



Activates 1mS Peak Hold on AC or DC volt and current functions. Activates the back light on the LCD.

b. Rotary Switch

- OFF Turns the 193A off.
-  Function for measuring AC/DC volts (ACV/DCV).
-  Function for measuring millivolts DC (DCmV).
-  Function for measuring resistance, diode testing and continuity buzzer
- Hz Function for measuring Frequency (Hz).
- TEMP Function for measuring Temperature (°C/°F)
-  Function for measuring AC/DC microamps (µA).
-  Function for measuring AC/DC milliamps (mA).
-  Function for measuring up to 10 AC/DC amps (A).
-  Function for measuring capacitance.
- IP Function for measuring RPM with inductive pick-up
- IG Function for measuring RPM, mS pulse width, Duty Cycle, Dwell Angle, and Frequency.

c. Input Jacks

- VΩHz Red test lead connection for all Volt, Ohm, Frequency, and IG functions.
- COM Black test lead connection for all functions.
- µmATEMP Red test lead connection for current measurements on the uA and mA functions.
- A Red test lead connection for current measurements on the A function.

d. Disable Auto Power Off

With the 193A turned on, press and hold down the CYL push button for 2 seconds. A confirmation beep will be heard and the  icon will go off in the upper left corner of the LCD. To enable, hold down the CYL push button for 2 seconds. The icon will reappear.

2. Step by Step Procedures:

a. MEASURING DC VOLTS



CAUTION!

Do not attempt to make a voltage measurement if a test lead is plugged in the A or μmA input jack. Instrument damage and/or personal injury may result.



WARNING!

Do not attempt to make a voltage measurement of more than 1000V or of a voltage level that is unknown.

Instrument set-up:

FUNCTION	BLACK TEST LEAD	RED TEST LEAD	MINIMUM READING	MAXIMUM READING
mV	COM	V Ω Hz	0.001mV	200.00mV
V	COM	V Ω Hz	0.0001V	1000V

Measurement Procedure:

1. Disconnect power to the circuit to be measured.
2. Plug the black test lead into the COM input jack.
3. Plug red test lead into the V Ω Hz input jack.
4. Set rotary switch to either the \overline{mV} or \tilde{V} function, depending on the voltage to be measured.
5. Connect the test leads to the circuit to be measured.
6. Reconnect power to the circuit to be measured.
7. Read the voltage on the 193A.

Optional Functions:



Manually select the appropriate range.



Activate MIN/MAX record mode (page 25).



Activate REL mode (page 25).



HOLD the reading on the LCD.
Activate Low Pass Filter (LPF page 26)



Activate 1mS Peak Hold (page 26)

b. MEASURING AC VOLTS



CAUTION!

Do not attempt to make a voltage measurement if a test lead is plugged in the A or μ mA input jack. Instrument damage and/or personal injury may result.



WARNING!

Do not attempt to make a voltage measurement of more than 750V or of a voltage level that is unknown.

Instrument set-up:

FUNCTION	BLACK TEST LEAD	RED TEST LEAD	MINIMUM READING	MAXIMUM READING
	COM	V Ω Hz	0.0001V	750V

Measurement Procedure:

1. Disconnect power to the circuit to be measured.
2. Plug the black test lead into the COM input jack.
3. Plug the red test lead into the V Ω Hz input jack.
4. Set the rotary switch to the function.
5. Press the AC/DC button so AC shows on the LCD.
6. Connect the test leads to the circuit to be measured.
7. Reconnect power to the circuit to be measured.
8. Read the voltage on the 193A.

Optional Functions:



Manually select the appropriate range.



Activate MIN/MAX record mode (page 25).



Activate REL mode (page 25).

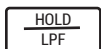

HOLD the reading on the LCD.
Activate Low Pass Filter (LPF page 26)



Activate 1mS Peak Hold (page 26).

c. MEASURING DC AMPS



CAUTION!

Do not attempt to make a current measurement with the test leads connected in parallel with circuit to be tested. Test leads must be connected in series with the circuit.



WARNING!

Do not attempt to make a current measurement of circuits with more than 600V present. Instrument damage and /or personal injury may result.

Instrument set-up:

FUNCTION	BLACK TEST LEAD	RED TEST LEAD	MINIMUM READING	MAXIMUM READING
μA	COM	$\mu\text{mA TEMP}$	$0.01\mu\text{A}$	$2000\mu\text{A}$
mA	COM	$\mu\text{mA TEMP}$	0.001mA	200mA
10A	COM	A	0.001A	10.00A

Measurement Procedure:

1. Disconnect power to circuit to be measured.
2. Plug the black test lead into the COM input jack.
3. Plug the red test lead into the $\mu\text{mA TEMP}$ or A input jack depending on the value of current to be measured.
4. Set the rotary switch to the μA , mA, or A function.
5. Connect test leads in series to circuit to be measured.
6. Reconnect power to the circuit to be measured.
7. Read the current on the 193A.

Optional Functions:



Manually select the appropriate range.



Activate MIN/MAX record mode (page 25).

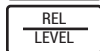

Activate REL mode (page 25).



HOLD the reading on the LCD.



Activate 1mS Peak Hold (page 26)

d. MEASURING AC AMPS



CAUTION!

Do not attempt to make a current measurement with the test leads connected in parallel with the circuit to be tested. Test leads must be connected in series with the circuit.



WARNING!

Do not attempt to make a current measurement of circuits with more than 600V present. Instrument damage and /or personal injury may result.

Instrument set-up:

FUNCTION	BLACK TEST LEAD	RED TEST LEAD	MINIMUM READING	MAXIMUM READING
μA	COM	μmATEMP	0.01 μA	2000 μA
mA	COM	μmATEMP	0.01mA	200mA
10A	COM	A	0.001A	10.00A

Measurement Procedure:

1. Disconnect power to the circuit to be measured.
2. Plug the black test lead into the COM input jack.
3. Plug the red test lead into the μmATEMP or A input jack depending on the value of current to be measured..
4. Set the rotary switch to the μA , mA or A function.
5. Press the AC/DC pushbutton to set to AC mode.
6. Connect test leads in series to circuit to be measured.
7. Reconnect power to the circuit to be measured.
8. Read the current on the 193A.

Optional Functions:



Manually select the appropriate range.



Activate MIN/MAX record mode (page 25).



Activate REL mode (page 25).



HOLD the reading on the LCD.



Activate 1mS Peak Hold (page 26)

e. MEASURING RESISTANCE



WARNING!

Do not attempt to make resistance measurements with circuit energized. For best results, remove the resistor completely from the circuit before attempting to measure it.

NOTE:

To make accurate low ohm measurements, short the ends of the test leads together and press the REL pushbutton. This value will automatically be deducted from your reading.

Instrument set-up:

FUNCTION	BLACK TEST LEAD	RED TEST LEAD	MINIMUM READING	MAXIMUM READING
Ω	COM	V Ω Hz	0.01 Ω	20.00M Ω

Measurement Procedure:

1. Disconnect power to the circuit to be measured.
2. Plug the black test lead into the COM input jack.
3. Plug the red test lead into the V Ω Hz input jack.
4. Set the rotary switch on the 193A to the Ω function.
5. Connect the test leads to the circuit to be measured.
6. Read the resistance value on the 193A.

Optional Functions:



Manually select the appropriate range.



Activate MIN/MAX record mode (page 25).

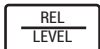

Activate REL mode (page 25).



Toggle between Continuity Buzzer, Diode Test, and Resistance measurement modes.



HOLD the reading on the LCD.

f. MEASURING DIODES



CAUTION!

Do not attempt to make diode measurements with circuit energized. The only way to accurately test a diode is to remove it completely from the circuit before attempting to measure it.

Instrument set-up:

FUNCTION	BLACK TEST LEAD	RED TEST LEAD	MINIMUM READING	MAXIMUM READING
	COM	V Ω Hz	0.001V	2.000V

Measurement Procedure:

1. Disconnect power to the circuit to be measured.
2. Plug the black test lead into the COM input jack.
3. Plug the red test lead into the V Ω Hz input jack.
4. Set the rotary switch to the function.
5. Press the FUNCTION button until the diode symbol shows on the LCD.
6. Connect black test lead to the banded end of the diode and the red test lead to the non-banded end of the diode.
7. Reading on the display should be between 0.5 and 0.8 volts.
8. Reverse test lead connections in 5 above.
9. Reading on the display should be OFL (Overload).

NOTE: If diode reads 0 in both directions, diode is shorted. If diode reads OFL in both directions, diode is open.

Optional Functions:



HOLD the reading on the LCD.

g. CONTINUITY BUZZER



WARNING!

Do not attempt to make continuity measurements with circuit energized.

Instrument set-up:

FUNCTION	BLACK TEST LEAD	RED TEST LEAD
	COM	V Ω Hz

Measurement Procedure:

1. Disconnect power to the circuit to be measured.
2. Plug the black test lead into the COM input jack.
3. Plug the red test lead into the V Ω Hz input jack.
4. Set the rotary switch to the  function.
5. Press yellow FUNCTION button until the continuity buzzer symbol shows on the LCD.
6. Connect the test leads to the circuit to be measured.
7. Listen for the buzzer to confirm continuity.

Optional Functions:



HOLD the reading on the LCD.

h. MEASURING CAPACITANCE



CAUTION!

Disconnect power to the circuit(s) to be measured. Discharge the capacitor to be measured completely before attempting to measure.

Instrument set-up:

FUNCTION	BLACK TEST LEAD	RED TEST LEAD	MINIMUM READING	MAXIMUM READING
	COM	VΩHz	0.01nF	10mF

Measurement Procedure:

1. Disconnect power and discharge the capacitor to be measured.
2. Plug the black test lead into the COM input jack.
3. Plug the red test lead into the VΩHz input jack.
4. Set the rotary switch to the function.
5. Connect the test leads to the capacitor to be measured.
6. Read the capacitance on the EEDM504C.

Optional Functions:



Manually select the appropriate range.



Activate REL mode (page 25).



Freeze the reading on the LCD.

h. MEASURING TEMPERATURE



CAUTION!

Disconnect power to the circuit(s) to be measured. Discharge the capacitor to be measured completely before attempting to measure.

Instrument set-up:

FUNCTION	TEMP. INPUT ADPT.	TEMP. INPUT ADPT.	MINIMUM READING	MAXIMUM READING
TEMP	COM	μ MATEMP	0.1°F 0.1°C	2462°F 1350°C

Measurement Procedure:

1. Remove test leads from the 193A.
2. Plug the "-" terminal of the temperature input adapter into the COM input jack.
3. Plug the "+" terminal of the temperature input adapter into the μ MATEMP input jack.
4. Set the rotary switch to the TEMP function.
5. Plug a K-type temperature probe into the temperature input adapter observing the correct polarity.
6. Read the temperature on the 193A.

Optional Functions:



Activate MIN/MAX record mode (page 25).



Activate REL mode (page 25).



Toggle between °C or °F.



HOLD the reading on the LCD.

i. MEASURING FREQUENCY



CAUTION!

Do not attempt to make a frequency measurement if a test lead is plugged in the A or μmA input jack. Instrument damage and/or personal injury may result.



WARNING!

Never attempt a frequency measurement with a voltage source reater than 600V

Instrument set-up:

FUNCTION	BLACK TEST LEAD	RED TEST LEAD	MINIMUM READING	MAXIMUM READING
Hz	COM	V Ω Hz	0.001Hz	10MHz

Measurement Procedure:

1. Disconnect power to the circuit to be measured.
2. Plug the black test lead into the COM input jack.
3. Plug the red test lead into the V Ω Hz input jack.
4. Set the rotary switch to the Hz function.
5. Connect the test leads to the circuit to be measured.
6. Reconnect power to the circuit to be measured.
7. Read the frequency on the 193A.

Optional Functions:



Manually select the appropriate range.



Activate MIN/MAX record mode (page 25).



Activate REL mode (page 25).



HOLD the reading on the LCD.

j. IP FUNCTION

Instrument set-up:

FUNCTION	BLACK TEST LEAD	RED TEST LEAD	MINIMUM READING	MAXIMUM READING
IP	COM	V Ω Hz	60RPM	12000RPM

Measurement Procedure:

1. Plug the "-" test lead of the inductive pick-up into the COM input jack.
2. Plug the "+" test lead of the inductive pick-up into the V Ω Hz input jack.
3. Set the rotary switch to the IP function.
4. Clamp the inductive pick-up around one spark plug wire observing correct orientation of pick-up to spark plug.
5. Press the STR button to select 2 or 4 stroke.
6. Read the RPM on the 193A.

Optional Functions to Stabilize Readings:



Toggles trigger from "+" to "-".



Changes the level of the trigger.



Activates the Noise Reduction circuit.

Optional Functions:



Hold button down for 2 seconds to activate Min/Max record mode (page 25).



Hold button down for 2 seconds to activate REL mode (page 25).

k. IG FUNCTION

Note: This function is mainly used on conventional ignition systems with a separate coil. The red lead is connected to the "-" terminal on the coil and the black lead to vehicle ground.

Instrument set-up:

FUNCTION	BLACK TEST LEAD	RED TEST LEAD	MINIMUM READING	MAXIMUM READING
RPM	COM	VΩHz	60RPM	12000RPM
Pulse Width	COM	VΩHz	0.2mS	199.9mS
Duty Cycle	COM	VΩHz	0.0%	99.9%
Dwell	COM	VΩHz	0.0°	356.4°
Frequency	COM	VΩHz	1Hz	1999.9Hz

Measurement Procedure:

1. Plug the black test lead into the COM input jack.
2. Plug the red test lead into the VΩHz input jack.
3. Set the rotary switch to the IG function.
4. Connect the test leads to the coil or device under test.
5. Press the STR button to select 2 or 4 stroke.
6. Read the RPM on the 193A.

Optional Functions to Stabilize Readings:



Toggles trigger from "+" to "-".



Changes the level of the trigger.



Activates the Noise Reduction circuit.

Optional Functions:



Hold button down for 2 seconds to activate Min/Max record mode (page 25).



Hold button down for 2 seconds to activate REL mode (page 25).

I. RECORD MODE (REC)

The record mode saves minimum (MIN), maximum (MAX), and average (AVE) values measured for a series of readings. Activate the function as follows:

1. Depress the REC/TRIG +/- button on the 193A.
2. The 193A will immediately start to record MIN/MAX/AVE values. REC will be on the LCD to show record mode has been activated. The reading on the LCD will be the actual reading.
3. Press the REC/TRIG +/- button a second time and the MIN reading will be displayed.
4. Press the REC/TRIG +/- button a third time and the AVE reading will be displayed on the LCD.
5. To terminate the record mode, hold the REC button down for approximately 2 seconds or turn the rotary switch to a different function.

m. RELATIVE MODE (REL)

The Relative mode compares readings to a known value and displays it as a difference to that value on the LCD.

1. Measure the known value on the 193A and press the REL button, the LCD will display zero.
2. Measure next device for comparison.
3. The LCD will display the difference between the new device and the stored reference value.
4. To terminate the Relative mode, hold the REL button down for approximately 2 seconds or turn the rotary switch to a different function.

n. LOW PASS FILTER (LPF)

The LPF mode is used to filter out AC or noise affecting DC voltage/current readings and harmonics affecting AC voltage/current readings. It will stabilize the reading and give you a more exact reading.

1. Depress and hold down the HOLD/LPF button for 2 seconds on the 193A.
2. The 193A will display LPF on the LCD when the low pass filter is active.
3. To terminate the LPF mode, depress and hold down the HOLD/LPF button down for 2 seconds. LPF will no longer be displayed on the LDC.

o. PEAK HOLD MODE (PEAK-H)

The Peak Hold function allows you to capture rapidly occurring spikes or drops in signals as fast as 1ms (one millisecond). You can monitor signals over time or test the spike when relays or coils are de-energized.

1. Measure the known device with the 193A and press the PEAK-H button.
2. Display will show the maximum (MAX) peak it measured since the button was depressed.
3. Press the PEAK-H button again to toggle between maximum (MAX) and minimum (MIN) stored values
4. To terminate the Peak Hold mode, hold the PEAK-H button down for approximately 2 seconds.

p. RS 232 COMMUNICATION

The 193A utilizes an optically isolated RS 232 communication format to insure safety to the user and computer. There is no physical connection between the meter and computer.

Please refer to the manual on the software CD for complete operating instructions.

F. MAINTENANCE

1. Testing Fuses In Circuit: Both the A and μ ATEMP input jacks are fuse protected. The fuses can be tested without removing them from the instrument as follows:
 - a. Set the 193A to the diode test function.
 - b. Insert the red test lead into the V input jack.
 - c. Touch the tip of the red test lead into the A input jack making sure you contact the metal.
 - d. If the display reads any number, the fuse is good. If the display reads .OL, the fuse is open and must be replaced.
 - e. Repeat the same procedure for the μ ATEMP input jack.

2. Fuse Replacement: Both the A and μ ATEMP input jacks are fuse protected. If either do not function, replace fuse as follows:
 - a. Disconnect and remove all test leads from live circuits and from the 193A.
 - b. Remove 193A from protective boot.
 - c. Remove the three screws from the lower back of housing holding the compartment cover in place.
 - d. Remove the compartment cover.
 - e. Remove the old fuse(s) and replace it with new fuse(s).
 - f. Reassemble the instrument in reverse order from above.

3. **Battery Replacement:** The 193A will display a battery symbol in the upper left corner of the LCD when the two internal 1.5 Volt "AAA" batteries need replacement. Batteries are replaced as follows:
 - a. Disconnect and remove all test leads from live circuits and from the 193A.
 - b. Remove 193A from protective boot.
 - c. Remove the three screws from the lower back of housing holding the compartment cover in place.
 - d. Remove the compartment cover.
 - e. Remove old batteries and replace with new batteries.
 - f. Reassemble instrument in reverse order from above.

Battery/Fuse Compartment

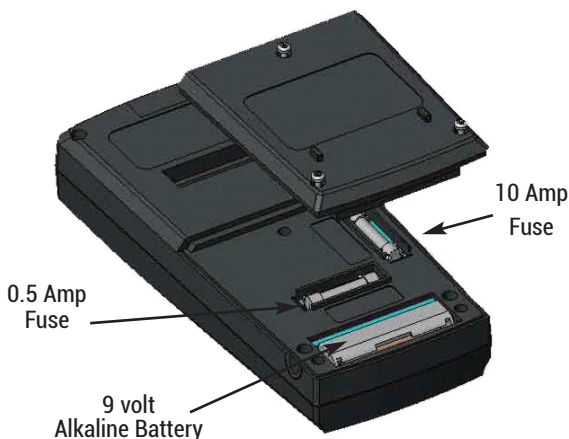

4. **Cleaning Your Meter:** The 193A can be wiped clean with a damp cloth and mild detergent. Do not submerge in water.

Notes:

Notes:



Test Products International, Inc.
9615 SW Allen Blvd., Ste. 104
Beaverton, OR 97005
Tel: 503-520-9197
www.testproductsintl.com

Test Products International, Ltd.
342 Bronte Road South, Unit #6
Milton Ontario Canada L9T 5B7
Tel: 905-693-8558
www.tpicanada.com

Test Products International Europe Ltd.
Rutherford Way Industrial Estate
Rutherford Way
Manor Royal
Crawley
West Sussex
RH10 9LN
www.tpieurope.com